

Floor Plan of Exhibit Hall C, Convention Center

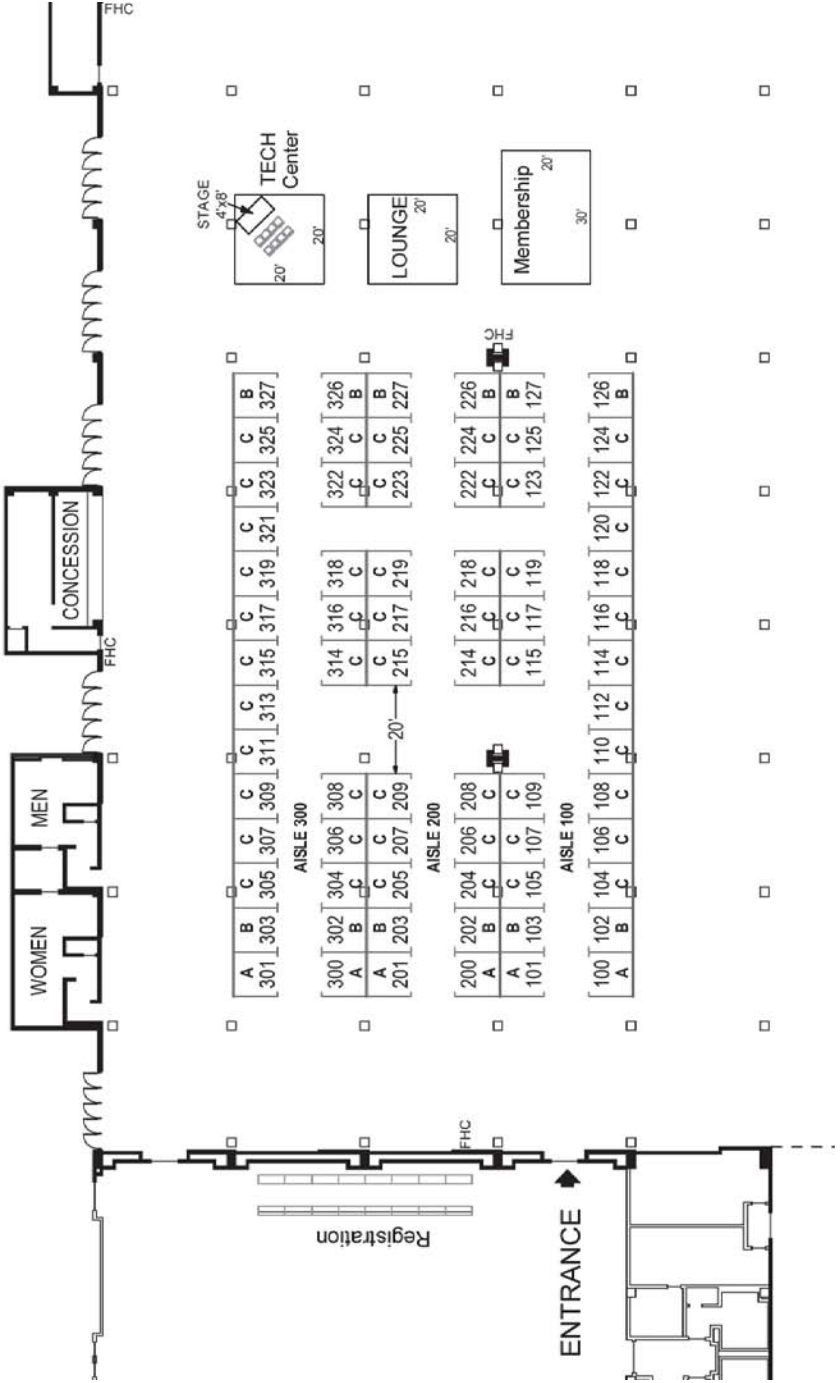

**2004 EXHIBITORS, San Antonio, TX
March 24–27, 2004**

Booth Numbers

Bedford/St. Martin's	200, 201, 202, 203, 204, 205
Composition Studies	323
Daedalus	324
Elsevier	317
Grammardog	124
Hackett Publishing Co.	120
Hampton Press, Inc.	226
Heinemann	305, 307, 309, 311, 313, 315
Houghton Mifflin Company	300, 302, 304, 306
Institute of General Semantics	227
International Writing Centers Association	322
JAC	327
Kendall/Hunt Publishing Co.	215, 217
Lawrence Erlbaum Associates	110, 112
Longman Publishers	114, 115, 116, 117, 118, 119
McGraw Hill Higher Education	214, 216, 218
Merriam-Webster, Inc.	219
Modern Language Association	222, 224
Newsweek Education Program	207
Oxford University Press	125
Pearson Education	101, 103
Penguin Academic Group	319
Prentice Hall	100, 102, 104, 106
Random House	301, 303
Routledge Publishing	105
Rowman & Littlefield Publishers	127 (Canceled)
Southern Illinois University Press	316, 318
South-Western/Thomson Corporation	108
State University of New York Press	308
T. H. Peek, Publisher	122
TYCA	126
University of Michigan Press	314
University of Pittsburgh Press	123
Utah State University Press	209
W.W. Norton & Company/College	223, 225
Wadsworth/Thomson Corporation	107, 109, 206, 208
Writing on the Edge	321

TABLES

ATTW
Editors Group
Progressive SIG/Caucus Coalition
Rhetoric and Composition Editors
Rhetoricians for Peace
Writing Program Administrators

Map of Hyatt San Antonio

Lobby Level

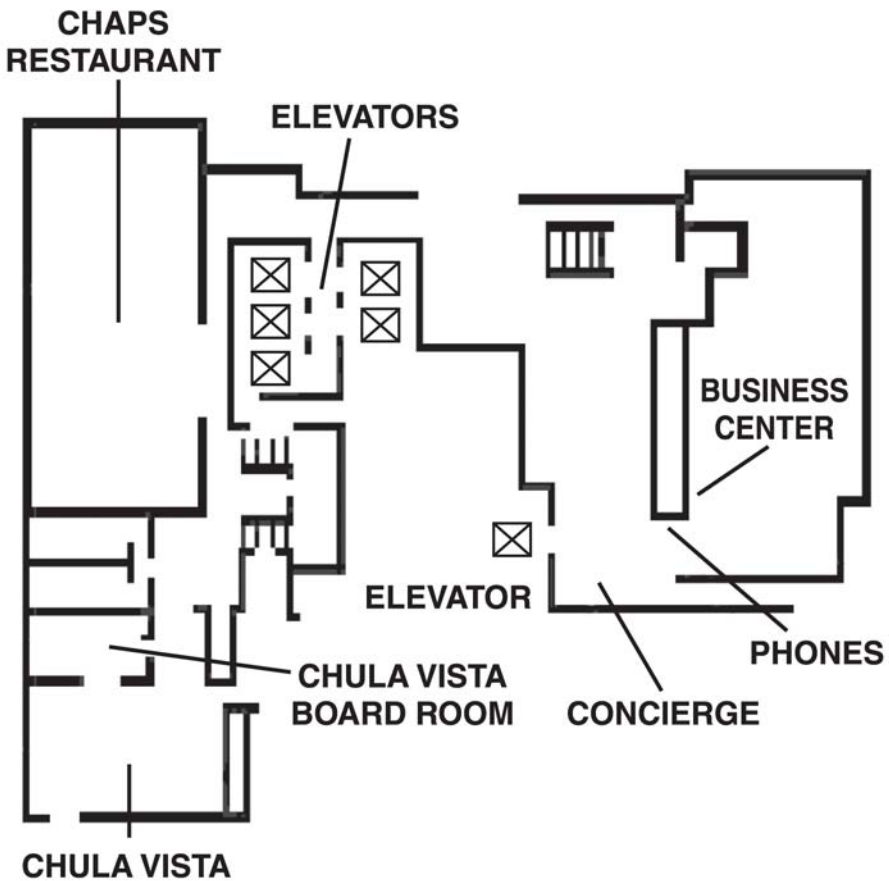

Map of Hyatt San Antonio

2nd Floor, B Level

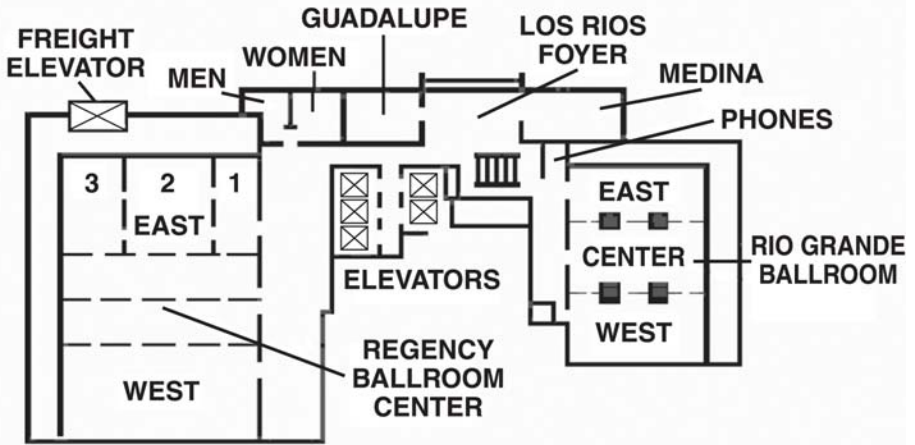

3rd Floor, A Level

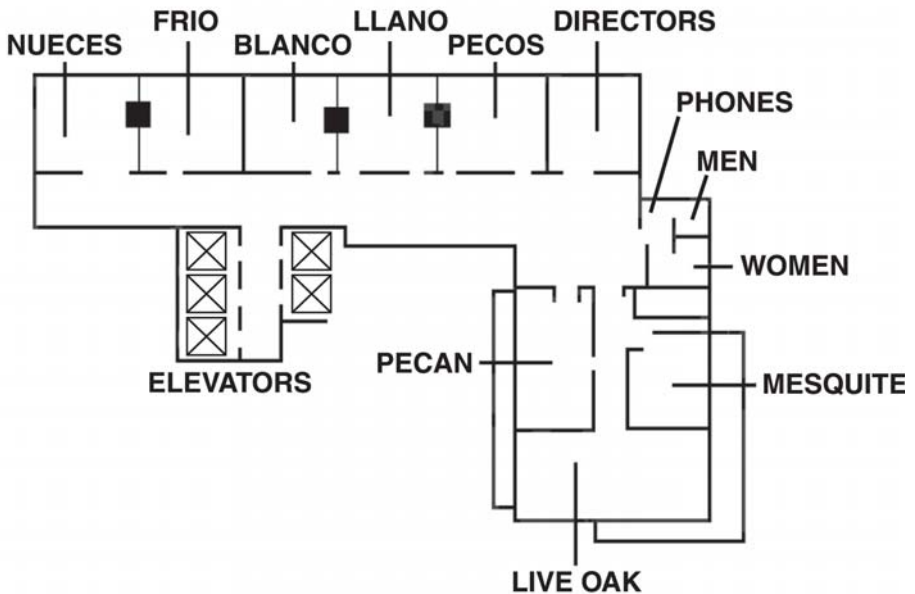

Henry B. Gonzalez Convention Center

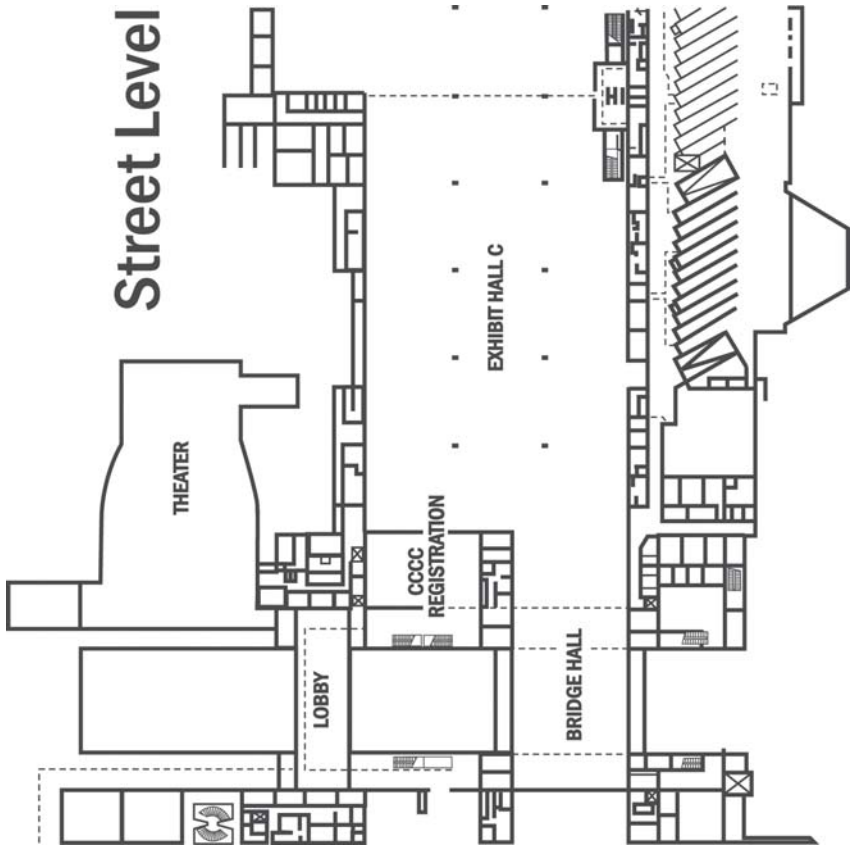

Henry B. Gonzalez Convention Center

Concourse Second Level

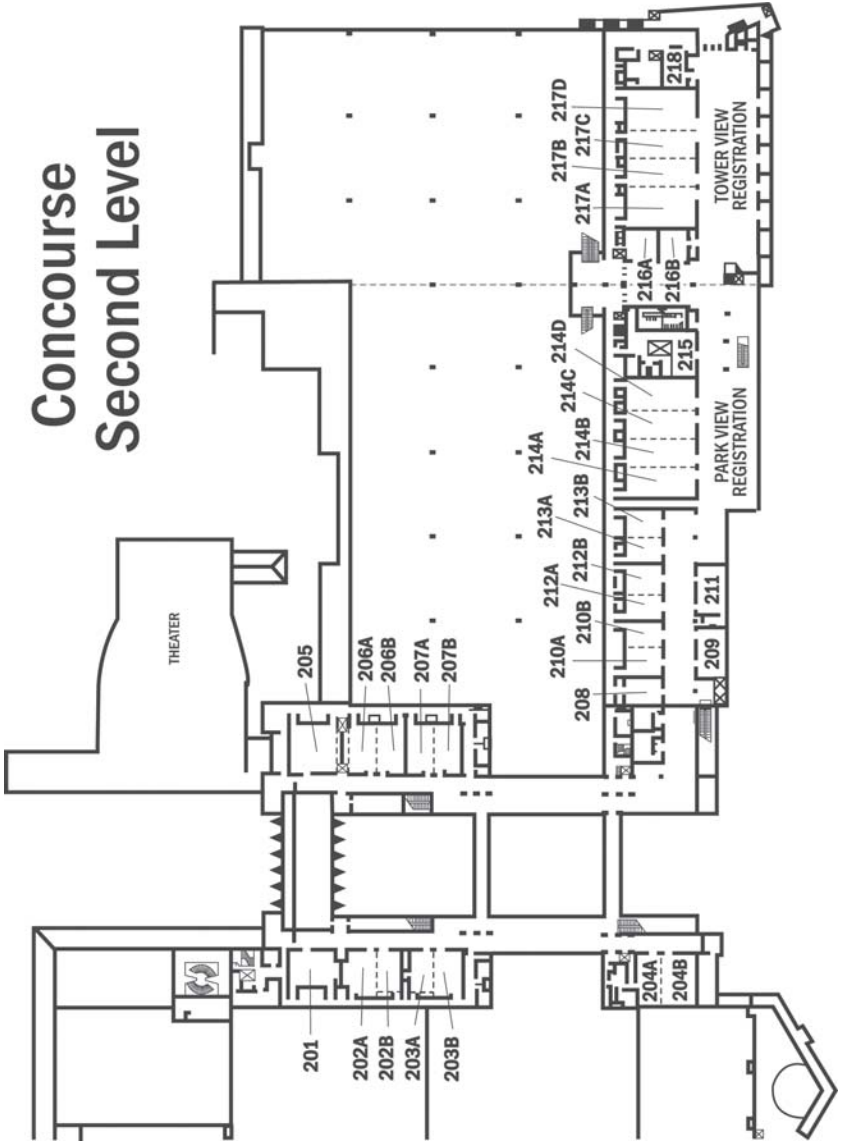

Map of Downtown San Antonio

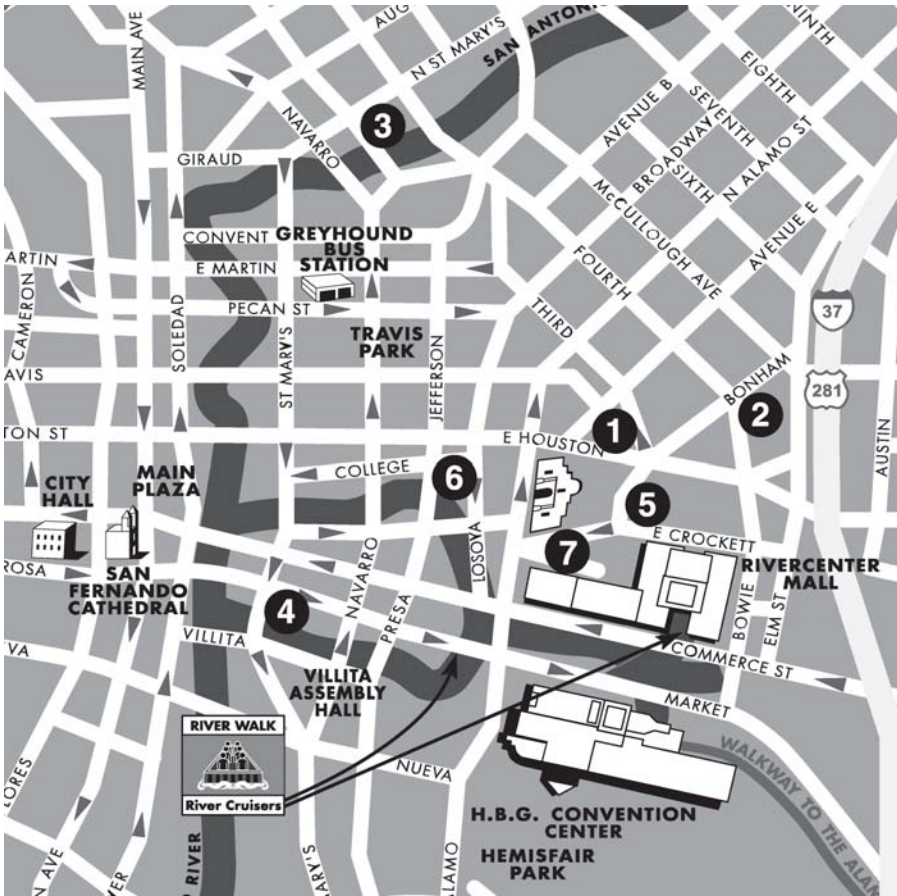

CCCC CONVENTION
SAN ANTONIO, TEXAS